

02 DOOR PLAN
SCALE: 1/2" = 1'

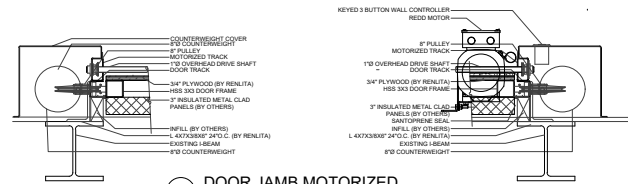

01 DOOR JAMB MOTORIZED
SCALE: 1-1/2" = 1'

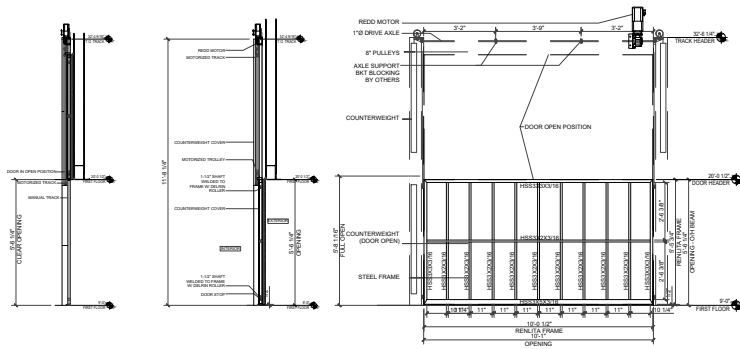

04 ELEVATION & SECTIONS MOTORIZED & NON
SCALE: 1/4" = 1'

GLAZING OPTIONS:

- 1/4" to 1" POLYCARBONATE
- 1/4" to 1" LAMINATED
- 1/4" to 1" TEMPERED
- 1" INSULATED

COLOR / FINISH OPTIONS:

- CUSTOM COLOR MATCHING
- CUSTOM CLADDING
- POWDER COATING
- GALVANIZED

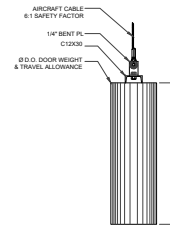

08 COUNTERWEIGHT TYP
SCALE: 1-1/2" = 1'

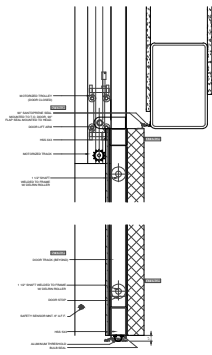

06 DOOR HEAD - SILL TYP
SCALE: 1-1/2" = 1'

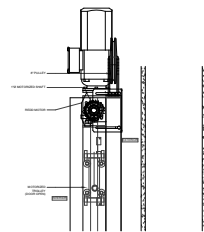

05 TOP OF TRACK
SCALE: 1-1/2" = 1'

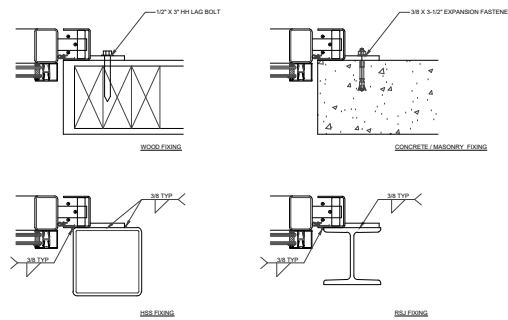

07 FIXING DETAILS TYP
SCALE: 3" = 1'

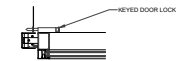

09 LOCK TYP (MANUAL ONLY)
SCALE: 1-1/2" = 1'

THESE DIMENSIONS AND DETAILS ARE THE PROPERTY OF FULL VIEW DOOR COMPANY. USE IS GRANTED FOR THE SOLE PURPOSE OF INTEGRATION OF OUR PRODUCT INTO YOUR PROJECT DRAWINGS AND TYPICAL IN ADVANCE AND FOR REFERENCE ONLY. NO DIMENSIONS BE REQUIRED AS SUCH DUE TO THE CUSTOM NATURE OF OUR PRODUCT SPECIFIC CONFIGURATIONS AND DIMENSIONS MAY VARY.

Full View Door Company

121 Main Ave.
Sacramento, CA 95838
Phone: 866-890-1776
www.fullviewdoorcompany.com

Client	Aviation - Vertical Slide
Project	
Sheet	
Scale	
Drawn By	
Checked By	
Issue No.	3K